

STANDARD EQUIPMENT

ENGINE

- Engine, HINO J05ETG, diesel engine with turbocharger and intercooler
- Automatic engine deceleration
- Auto Idle Stop (AIS)
- Batteries (2 x 12V - 104Ah)
- Starting motor (24V - 5 kW), 1.2kW alternator
- Automatic engine shut-down for low engine oil pressure
- Engine oil pan drain cock
- Double element air cleaner
- Pre-air cleaner

CONTROL

- Working mode selector (H-mode, S-mode and ECO-mode)
- Power Boost

SWING SYSTEM & TRAVEL SYSTEM

- Straight propel system
- Two-speed travel with automatic shift down
- Sealed & lubricated track links
- Grease-type track adjusters
- 600mm HD triple grouser shoe
- Automatic swing brake
- Travel alarm

HYDRAULIC

- Boom regeneration system
- Arm interflow system
- Auto warm up system
- Aluminum hydraulic oil cooler
- Hydraulic fluid filter clog detector
- 1 way piping (Breaker)

MIRRORS & LIGHTS

- Two rear view mirrors
- Five front working lights (One for boom, one for boom cylinder, one for right storage box and two for cab)

CAB & CONTROL

- Two control levers, pilot-operated
- Horn, electric
- Rops cab, all weather sound suppressed type
- Cab light (interior)
- Luggage tray
- Large cup holder
- Detachable two-piece floor mat
- Headrest
- Handrails
- Intermittent windshield wiper with double-spray washer
- Tinted safety glass
- Pull-up type front window and removable lower front window
- Easy-to-read multi-display color monitor
- Automatic air conditioner
- Emergency escape hammer
- Excavator Remote Monitoring System
- 7-way adjustable suspension seat
- Double slide seat
- 24V outlet

OPTIONAL EQUIPMENT

- Refilling pump
- Rear view camera
- Cab guards
- Rotating beacon
- 2 way piping (Nibbler & Breaker)
- Various optional buckets

Note: Standard and optional equipment may vary. Consult your KOBELCO dealer for specifics.

EXCAVATOR REMOTE MONITORING SYSTEM

Remote Monitoring System is a satellite-based system for receiving machine information. Manage your machines anywhere in the world using the Internet. Location, workload and diagnostic data aid business operations.

Direct Access to Operational Status

Location Data

Accurate location data can be obtained even from sites where communications are difficult.

Operating Hours

A comparison of operating times of machines at multiple locations shows which locations are busier and more profitable. Operating hours on site can be accurately recorded, for running time calculations needed for rental machines, etc.

Fuel Consumption Data

Data on fuel consumption and idling times can be used to indicate improvements in fuel consumption.

Graph of Work Content

The graph shows how working hours are divided among different operating categories, including digging, idling, traveling, and optional operations (NGB).



Maintenance Data and Warning Alerts

Machine Maintenance Data

Provides maintenance status of separate machines operating at multiple sites. Maintenance data is also relayed to KOBELCO service personnel, for more efficient planning of periodic servicing.

Security System

Engine Start Alarm

Sends a notification if the engine is started outside of pre-defined hours.

Area Alarm

Sends a notification if the machine leaves a pre-defined area.

Note: Remote monitoring system is not applicable in some area due to country regulation of the communication lines or availability of infrastructure.

Note: This catalog may contain attachments and optional equipment that are not available in your area. And it may contain photographs of machines with specifications that differ from those of machines sold in your areas. Please consult your nearest KOBELCO distributor for those items you require. Due to our policy of continuous product improvements all designs and specifications are subject to change without advance notice. Copyright by KOBELCO CONSTRUCTION MACHINERY CO., LTD. No part of this catalog may be reproduced in any manner without notice.

KOBELCO CONSTRUCTION MACHINERY CO., LTD.

5-15, Kitashinagawa 5-chome, Shinagawa-ku, Tokyo 141-8626 JAPAN
Tel: +81 (0) 3-5789-2146 Fax: +81 (0) 3-5789-2135
<https://www.kobelcocm-global.com/>

Inquiries To:

- **Bucket Capacity :**
0.80 - 1.20m³ (ISO heaped)
- **Engine Power :**
118KW / 2,000 min⁻¹
(ISO 14396)
- **Operating Weight :**
21,800 kg - 22,000 kg



Power Meets Efficiency

Increase in productivity means "Power"

19%*
Higher fuel Saving means "Efficiency"

In line with KOBELCO's concept of mining-friendly construction machinery that will work long and hard on any site on the planet, the rugged machine body is newly designed, and comprehensive reinforcement makes the attachment more robust.

It all adds up to KOBELCO's toughest ever mining excavator. The latest hydraulics technology delivers both high-powered output and lower fuel consumption.

As the 10th generation model of KOBELCO's SK series, the SK220XD/SK220XDLC meets the needs of the most punishing mining sites with a performance that simply astounds.



*in ECO-mode compared to S-mode on the SK210HDL-8

Even stronger attachment

Increase in productivity means "Power"

The boom and arm that take the greatest punishment are significantly reinforced.

Reinforced arm exhibits strength

Thick steel plate **NEW**



Arm top
Thickness of steel plate has been increased.

Arm foot
Base plate thickness has been increased.

Modified Foot Boss Shape **NEW**

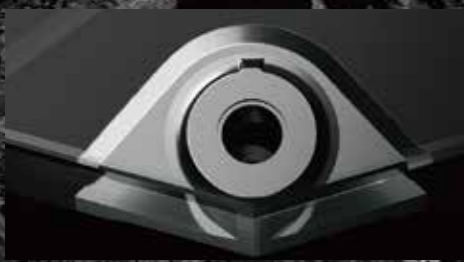

The arm foot boss shape has been modified and improved to distribute stress, delivering more strength for tasks like digging next to a wall.



Rock Guards

Specially designed long, solid rock guards installed to prevent damage to arm.

Upper under covers protect machine body

Upper Under Covers



Thick covers with increased durability compared to standard models.

Newly developed mining boom made of thicker steel plate

Featuring an XD Boom **NEW**

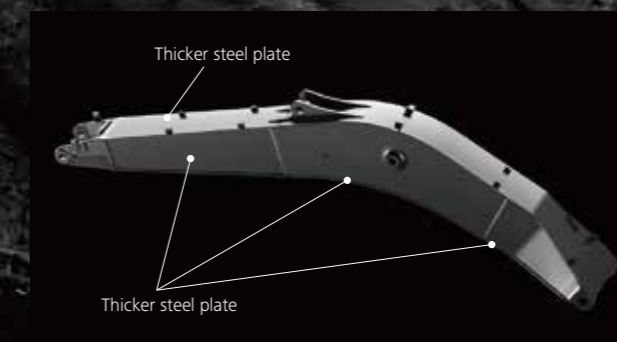

The XD boom features stronger plates compared to the HD booms of standard machines, which increases longevity even under the toughest working conditions.

Big cross-section boom



Big cross-section boom for unbeatable durability under harsh working conditions

Increase in productivity means "Power"

Powerful travel system for easy transit over loose rocks, and highly reliable filtration system ensure higher machine performance.

Crawlers Built for Unbeatable Durability



Reinforced Guide Frame

Reinforced guide frame prevents deformation caused by impact or encroaching of loose stones.



Track Guides

Large, reinforced track guides are installed in three locations.



Thicker steel plate for shoes

Reinforced HD shoes of thick steel plate to master rough, stony ground.



Track Links

The size and durability of the track link are increased compared to standard models.



Reinforced Travel Motor Cover

Rear of travel motor cover is reinforced.



Lower Frame Underside Cover

Hydraulic piping and equipment protected against damage from rubble and stony ground.

Improved Filtration System Reliability

Clean, contaminant-free fuel and hydraulic fluid are essential to stable performance.

The improved filtration systems reduce the risk of mechanical trouble and enhance longevity and durability.

Fuel filter ^{NEW}

The pre-filter with built-in water separator has 1.6 times more filter area compared to the previous models and with a new final stage maintenance free fuel filter to maximize filtering performance.

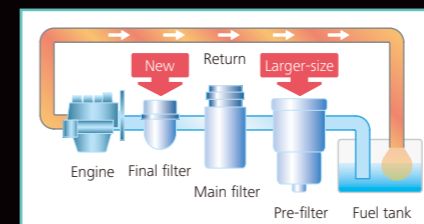

Hydraulic Fluid Filter ^{NEW}

Recognized as the best in the industry, our super-fine filter separates out even the smallest particles. New cover prevents contamination when changing filters.

Metal mesh cover air cleaner ^{NEW}

Metal mesh cover ensures strength and durability.



Hydraulic Fluid Filter Clog Detector ^{NEW}

Hydraulic tank pressure sensor monitors the pressure difference between the return line and tank inside pressure to determine the degree of clogging. If the difference exceeds a predetermined level, a warning appears on the multi-display, so any contamination can be trapped by the filter and replaced before it reaches the hydraulic fluid in the tank.

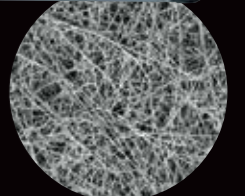
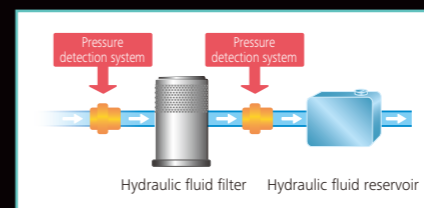

Enlarged filter image

Evolution Continues, with Improved Fuel Efficiency.

19%*
Higher fuel Saving means "Efficiency"

The new arm regeneration flow system more efficiently controls hydraulic fluid flow, and significant reduction of in-line resistance and pressure loss boosts fuel efficiency by about 19%*.

* in ECO-mode compared to S-mode on the SK210HDLC-8



2.40 m arm (Bucket capacity 1.10m³)

■ Max. Bucket Digging Force	■ Max digging reach:
Normal: 143kN	9,420 mm
With power boost: 157kN	■ Max digging depth:
■ Max. Arm crowding Force	6,160 mm
Normal: 121kN	■ Max vertical digging depth:
With power boost: 133kN	5,570 mm

2.94 m arm (Bucket capacity 0.80m³)

■ Max. Bucket Digging Force	■ Max digging reach:
Normal: 143kN	9,900 mm
With power boost: 157kN	■ Max digging depth:
■ Max. Arm crowding Force	6,700 mm
Normal: 102kN	■ Max vertical digging depth:
With power boost: 112kN	6,100 mm

Piping for Breaker

Piping for breaker is fitted as standard.



In Pursuit of Improved Fuel Efficiency

Operation Mode NEW

Fuel consumption is lower in H-mode/S-mode/ECO-mode in comparison with the previous model (Generation 8).

■ Compared to previous models

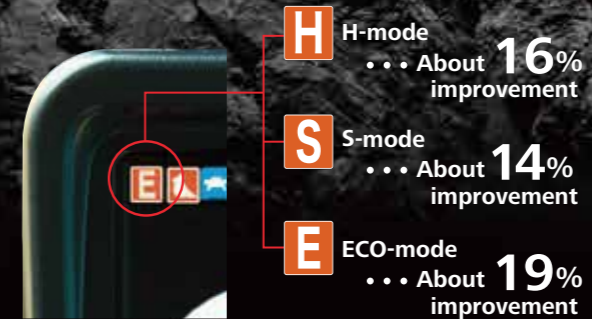

AIS (Auto Idle Stop)

If the boarding/disembarking lever is lifted up, the engine will stop automatically. This eliminates wasteful idling during standby, saving fuel and reducing CO₂ emissions as well.

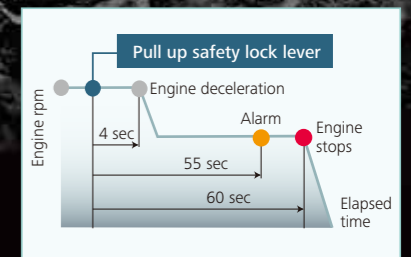

Hydraulic System: Revolutionary Technology Saves Fuel

Arm Interflow System NEW

When lowering the boom, this system uses the downward force generated by the boom's weight to push fluid to the excavator arm cylinder. This greatly reduces the need to apply power from outside the system.

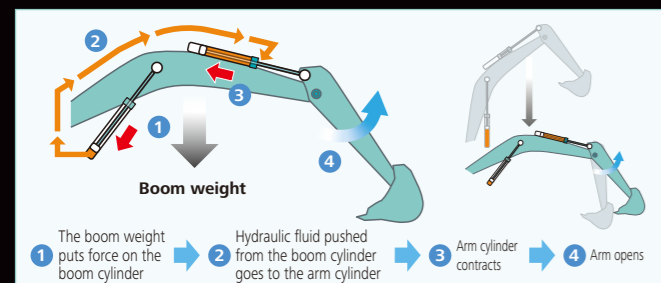

Hydraulic circuit reduces energy loss

We have made every effort to enhance fuel efficiency by minimizing hydraulic pressure resistance, improving the hydraulic line layout to control friction resistance loss and minimizing valve resistance.

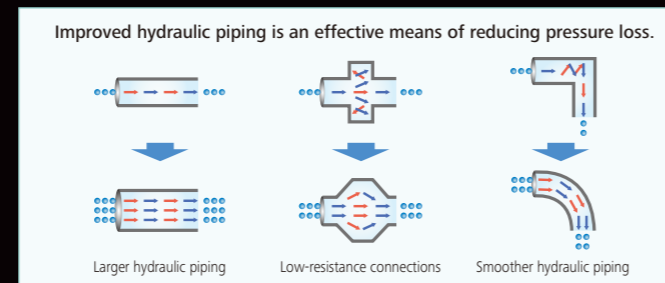

Pursuing maximum fuel efficiency

Common rail system

High-pressure injection atomizes the fuel, and more precise injection improves combustion efficiency. This also contributes to better fuel economy.

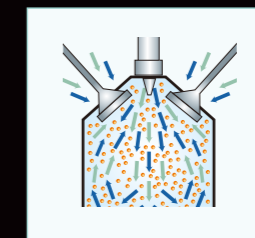

Comfortable Cab Is Now Safer than Ever.

A work environment that is quieter and more comfortable. A cab that puts the operator first is key to improved safety.



Large cab ^{NEW}

4 % larger than the previous cab capacity. Relaxing environment allows work to be performed in comfort.

Air Conditioner ^{NEW} Louvers behind the Seat



The large air-conditioner has louvers on the back pillars that blow from behind and to the right and left of the operator's seat. They can be adjusted to put a direct flow of cool/warm air on the operator, which means a more comfortable operating environment.

Super-Airtight Cab ^{NEW}



The high level of air-tightness keeps dust out of the cab.

Low Vibration ^{NEW}

Coil springs absorb small vibrations, and high suspension mounts filled with silicone oil reduce heavy vibration. The long stroke achieved by this system provides excellent protection from vibration.

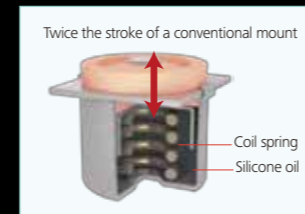

Multi-Display in Color ^{NEW}

Brilliant colors and graphic displays are easy to recognize on the LCD multi-display in the console. The display shows fuel consumption, maintenance intervals, and more.



- 1 Analog gauge provides an intuitive reading of fuel level and engine water temperature
- 2 Green indicator light shows low fuel consumption during operation
- 3 Fuel consumption/Switch indicator for rear camera images
- 4 Digging mode switch
- 5 Monitor display switch

One-Touch Attachment Mode Switch

A simple touch of a button, switches the hydraulic circuit and flow amount to match attachment changes. Icons help the operator to confirm the proper configuration at a glance.

Comfort



Broad View ^{NEW} Liberates the Operator

The front window features one large piece of glass without a center pillar on the right side for a wide, unobstructed view.

Large Cab Is Easy ^{NEW} to Get in and Out of

The expanded cab provides plenty of room for a large door, more headroom and smoother entry and exit.



More Comfortable Seat Means Higher Productivity



A Light Touch on the ^{NEW} Lever Means Smoother, Less Tiring Work



It takes 38% less effort to work the operation lever, which reduces fatigue over long working hours or continued operations.

Interior Equipment Adds to Comfort and Convenience

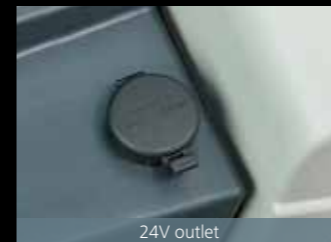

Safety

ROPS Cab ^{NEW}

ROPS (Roll-Over-Protective Structure)-compliant cab clears ISO standards (ISO-12117-2: 2008) and ensures greater safety for the operator should the machine tip over.



Wide view during operations High Visibility for Safety



Greater safety assured by rearview mirrors on left and right.

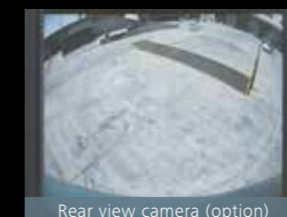

A rear view camera is installed as option to simplify checking for safety behind the machine. The picture appears on the monitor.

Efficient Maintenance Keeps the Machine in Peak Operating Condition.



Examples of displaying maintenance information

Machine Information Display Function

- Displays only the maintenance information that's needed, when it's needed
- Self-diagnostic function provides early-warning detection and display of electrical system malfunctions
- Service-diagnostic function makes it easier to check the status of the machine
- Record function of previous breakdowns including irregular and transient malfunction

Easy, On-the-Spot Maintenance

There is ample space in the engine compartment for a mechanic to do maintenance work inside. The distance between steps is lower so entry and exit is easier. And the mechanic can work in comfort, without contortions or unnatural body positions. Finally, the hood is lighter and easier to raise and lower.



Generous space for maintenance work



Step/Hand rail



Double-element air cleaner



Left side

Laid out for easy access to radiator and cooling system elements



Fuel filter with built-in water-separator / Fuel filter



Right side

- ① Fuel filter
- ② Fuel filter with built-in water-separator
- ③ Engine oil filter

Easy Cleaning



Crawler frame

Special crawler frame design for easy mud removal cleaning.

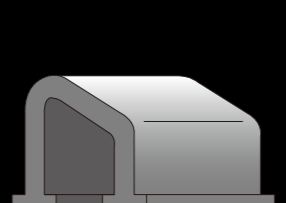

Detachable two-piece floor mat



Detachable two-piece floor mat with handles for easy removal. A floor drain is located under floor mat.

Detachable two-piece floor mat with handles for easy removal. A floor drain is located under floor mat.



Engine oil pan

Engine oil pan equipped with drain valve.

More Efficient Maintenance Inside the Cab

Internal and external air conditioner filters can be easily removed without tools for cleaning.



Air conditioner filters

Specifications

Engine

Model	HINO J05ETG
Type	Four-stroke liquid-cooled direct injection diesel turbo charged with intercooler
No. of cylinders	4
Bore and stroke	112 mm X 130 mm
Displacement	5.123 L
Rated power output	114 kW/2,000 min ⁻¹ (ISO9249) 118 kW/2,000 min ⁻¹ (ISO14396)
Max. torque	569 N·m/1,600 min ⁻¹ (ISO9249) 592 N·m/1,600 min ⁻¹ (ISO14396)

Hydraulic System

Pump	
Type	Two Variable displacement piston pumps + one gear pump
Max. discharge flow	2 X 220 L/min, 1 X 20 L/min
Relief valve setting	
Boom, arm and bucket	34.3 MPa (350 kgf/cm ²)
Power Boost	37.8 MPa (385 kgf/cm ²)
Travel circuit	34.3 MPa (350 kgf/cm ²)
Swing circuit	29.0 MPa (296 kgf/cm ²)
Control circuit	5.0 MPa (50 kgf/cm ²)
Pilot control pump	Gear type
Main control valves	8-spool valve
Oil cooler	Air cooled type

Swing System

Swing motor	One fixed displacement piston pump
Brake	Hydraulic; locking automatically when the swing control lever is in the neutral position
Parking brake	Wet multiple plate
Swing speed	13.3 min ⁻¹ (rpm)

Attachments

Backhoe bucket and arm combination

Type	Backhoe bucket						
	ISO heaped	m ³	0.80 (0.70) Side pin type	0.93 (0.80) Side pin type	1.05 (0.90) Side pin type	1.10 (0.95) Side pin type	1.20 (1.00) Side pin type
Bucket capacity	ISO struck	m ³	0.59	0.67	0.75	0.80	0.84
Opening width	With side cutter	mm	1,160	1,390	1,450	1,490	1,610
	Without side cutter	mm	1,140	1,230	1,330	1,380	1,490
No. of teeth			5	5	5	5	6
Bucket weight		kg	780	870	960	970	1,030
Combination	2.40 m arm		○	○	○	◎	△
	2.94 m arm		◎	○	△	×	×

◎ Standard ○ Recommended △ Loading only × Not recommended

Travel System

Travel motors	2 X axial-piston. Two-step motors	
Travel brakes	Hydraulic	
Parking brakes	Wet multiple plate	
Travel shoes	SK220XD	46 each side
	SK220XDLC	49 each side
Travel speed	6.0/3.6 km/h	
Drawbar pulling force	228 kN (SAE)	
Gradeability	70 % {35°}	
Ground clearance	435 mm	

Cab & Control

Cab	
All-weather, sound-suppressed steel cab mounted on the high suspension mounts filled with silicone oil and equipped with a heavy, insulated floor mat.	
Control	
Two hand levers and two foot pedals for travel	
Two hand levers for excavating and swing	
Electric rotary-type engine throttle	

Boom, Arm & Bucket

Boom cylinders	120 mm X 1,355 mm
Arm cylinder	135 mm X 1,558 mm
Bucket cylinder	120 mm X 1,080 mm

Refilling Capacities & Lubrications

Fuel tank	320 L
Cooling system	18 L
Engine oil	20.5 L
Travel reduction gear	2 X 5 L
Swing reduction gear	3 L
Hydraulic oil tank	140 L tank oil level
	244 L hydraulic system

Working Ranges

Unit: m

Boom	5.65 m	
Range	Arm	2.94 m / 2.40 m
a- Max. digging reach		9.9 / 9.42
b- Max. digging reach at ground level		9.73 / 9.24
c- Max. digging depth		6.7 / 6.16
d- Max. digging height		9.72 / 9.51
e- Max. dumping clearance		6.91 / 6.68
f- Min. dumping clearance		2.43 / 2.98
g- Max. vertical wall digging depth		6.1 / 5.57
h- Min. swing radius		3.54 / 3.56
i- Horizontal digging stroke at ground level		5.27 / 4.08
j- Digging depth for 2.4 m (8') flat bottom		6.52 / 5.95
Bucket capacity ISO heaped m ³		0.80 / 1.10

Digging Force (ISO 6015) Unit: kN

Arm length	2.94 m	2.40 m
Bucket digging force	143 / 157*	143 / 157*
Arm crowding force	102 / 112*	121 / 133*

*Power Boost engaged.

Dimensions

Arm length	2.94 m	2.40 m
A Overall length	9,600	9,680
B Overall height (to top of boom)	2,980	3,220
C Overall width	SK220XD	2,800
	SK220XDLC	2,990
D Overall height (to top of cab)	SK220XD	3,020
	SK220XDLC	3,020
E Ground clearance of rear end*	SK220XD	1,070
	SK220XDLC	1,070
F Ground clearance*	SK220XD	435
	SK220XDLC	435

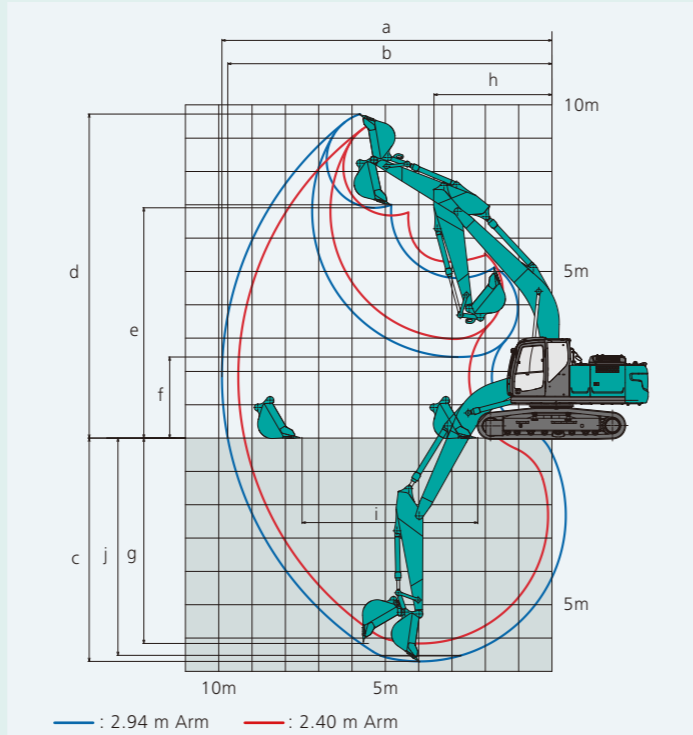

Unit: mm

G Tail swing radius		2,910
G' Distance from center of swing to rear end		2,900
H Tumbler distance	SK220XD	3,370
	SK220XDLC	3,660
I Overall length of crawler	SK220XD	4,180
	SK220XDLC	4,460
J Track gauge	SK220XD	2,200
	SK220XDLC	2,390
K Shoe width		600
L Overall width of upperstructure		2,710

*Without including height of shoe lug

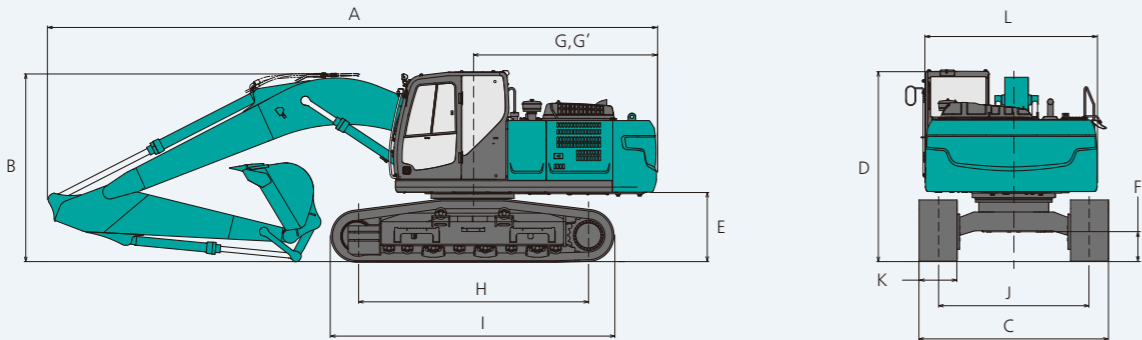

Operating Weight & Ground Pressure

In standard trim, with standard boom, 2.40 m arm, and 1.10 m³ ISO heaped bucket

Shaped	Triple grouser shoes (even height)	
Model		SK220XD
Shoe width	mm	600
Overall width	mm	2,800
Ground pressure	kPa	49
Operating weight	kg	21,800

In standard trim, with standard boom, 2.94 m arm, and 0.80 m³ ISO heaped bucket

Shaped	Triple grouser shoes (even height)	
Model		SK220XDLC
Shoe width	mm	600
Overall width	mm	2,990
Ground pressure	kPa	46
Operating weight	kg	22,000

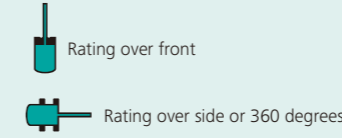
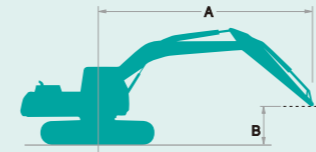

A: Reach from swing centerline to arm top
B: Arm top height above/below ground
C: Lift point
Bucket: Without bucket
Relief valve setting: 34.3MPa (350kgf/cm²)

SK220XD	Boom: 5.65 m Arm: 2.40 m, Bucket: without, Shoe: 600 mm													
A	B		3.0 m			4.5 m		6.0 m		7.5 m		At Max. Reach		
												Radius		
7.5 m	kg											*5,730	5,320	5.59 m
6.0 m	kg						*5,820	4,760				*5,210	3,830	6.80 m
4.5 m	kg				*7,440	7,150	*6,220	4,600	4,900	3,200		4,870	3,180	7.52 m
3.0 m	kg				*9,080	6,540	6,770	4,350	4,810	3,120		4,430	2,870	7.89 m
1.5 m	kg				10,110	6,070	6,510	4,110	4,700	3,010		4,300	2,760	7.97 m
G.L.	kg				9,870	5,870	6,350	3,970	4,630	2,950		4,420	2,820	7.75 m
-1.5 m	kg	*10,410	*10,410	9,850	5,860	6,310	3,930					4,890	3,110	7.22 m
-3.0 m	kg	*11,750	11,440	*8,830	5,990	*6,420	4,040					*5,880	3,830	6.28 m
-4.5 m	kg			*5,510	*5,510							*5,050	*5,050	4.71 m

SK220XD	Boom: 5.65 m Arm: 2.94 m, Bucket: without, Shoe: 600 mm															
A	B		1.5 m		3.0 m		4.5 m		6.0 m		7.5 m		At Max. Reach			
													Radius			
7.5 m	kg								*4,810	*4,810			*3,850	*3,850	6.26 m	
6.0 m	kg								*5,260	4,830			*3,560	3,370	7.36 m	
4.5 m	kg								*5,740	4,650	4,940	3,230	*3,480	2,850	8.03 m	
3.0 m	kg						*8,370	6,670	*6,490	4,370	4,810	3,110	*3,550	2,590	8.38 m	
1.5 m	kg						*9,860	6,120	6,510	4,100	4,670	2,980	*3,760	2,490	8.45 m	
G.L.	kg					*5,750	*5,750	9,830	5,820	6,310	3,920	4,560	2,880	3,990	2,530	8.25 m
-1.5 m	kg	*6,080	*6,080	*10,050	*10,050	9,740	5,750	6,220	3,840	4,540	2,860	4,350	2,750	7.75 m		
-3.0 m	kg	*10,650	*10,650	*13,030	11,150	*9,380	5,820	6,280	3,890			5,190	3,270	6.89 m		
-4.5 m	kg			*9,600	*9,600	*7,030	6,080					*5,280	4,630	5.49 m		

SK220DLC	Boom: 5.65 m Arm: 2.40 m, Bucket: without, Shoe: 600 mm													
A	B		3.0 m		4.5 m		6.0 m		7.5 m		At Max. Reach			
												Radius		
7.5 m	kg											*5,730	*5,730	5.59 m
6.0 m	kg						*5,820	5,270				*5,210	4,240	6.80 m
4.5 m	kg				*7,440	*7,440	*6,220	5,100	*5,310	3,560		*5,080	3,540	7.52 m
3.0 m	kg				*9,080	7,330	*6,910	4,840	5,430	3,470		5,000	3,200	7.89 m
1.5 m	kg				*10,340	6,850	7,410	4,600	5,310	3,370		4,860	3,090	7.97 m
G.L.	kg				*10,680	6,640	7,240	4,450	5,240	3,300		5,010	3,160	7.75 m
-1.5 m	kg	*10,410	*10,410	*10,200	6,630	7,210	4,420					5,550	3,490	7.22 m
-3.0 m	kg	*11,750	*11,750	*8,830	6,760	*6,420	4,530					*5,880	4,290	6.28 m
-4.5 m	kg			*5,510	*5,510							*5,050	*5,050	4.71 m

SK220DLC	Boom: 5.65 m Arm: 2.94 m, Bucket: without, Shoe: 600 mm														
A	B		1.5 m		3.0 m		4.5 m		6.0 m		7.5 m		At Max. Reach		
													Radius		
7.5 m	kg								*4,810	*4,810			*3,850	*3,850	6.26 m
6.0 m	kg								*5,260	*5,260			*3,560	*3,560	7.36 m
4.5 m	kg								*5,740	5,150	*5,270	3,590	*3,480	3,180	8.03 m
3.0 m	kg						*8,370	7,470	*6,490	4,870	5,430	3,470	*3,550	2,890	8.38 m
1.5 m	kg						*9,860	6,900	*7,240	4,600	5,280	3,330	*3,760	2,790	8.45 m
G.L.	kg				*5,750	*5,750	*10,540	6,600	7,200	4,410	5,180	3,240	*4,150	2,840	8.25 m
-1.5 m	kg	*6,080	*6,080	*10,050	*10,050	*10,380	6,510	7,110	4,330	5,150	3,210	4,880	3,090	7.75 m	
-3.0 m	kg	*10,650	*10,650	*13,030	12,880	*9,380	6,590	*6,940	4,380			*5,620	3,670	6.89 m	
-4.5 m	kg			*9,600	*9,600	*7,030	6,860					*5,280	5,190	5.49 m	

Notes:

- Do not attempt to lift or hold any load that is greater than these lift capacities at their specified lift point radius and heights. Weight of all accessories must be deducted from the above lift capacities.
- Lift capacities are based on machine standing on level, firm, and uniform ground. User must make allowance for job conditions such as soft or uneven ground, out of level conditions, side loads, sudden stopping of loads, hazardous conditions, experience of personnel, etc.
- Arm top defined as lift point.
- The above lift capacities are in compliance with ISO 10567. They do not exceed 87% of hydraulic lift capacity or 75% of tipping load. Lift capacities marked with an asterisk (*) are limited by hydraulic capacity rather than tipping load.
- Operator should be fully acquainted with the Operator's and Maintenance Instructions before operating this machine. Rules for safe operation of equipment should be adhered to at all times.
- Lift capacities apply to only machine as originally manufactured and normally equipped by KOBELCO CONSTRUCTION MACHINERY CO., LTD.